

SAGITTARIUS

TAPS & SHOWERING

Construction	Brass & Zinc Alloy
Finishes	Chrome plated to BS EN 248
Product Type	Contemporary
Plumbing Systems	Suitable for all plumbing systems
Size	320mm
Fitting	G1-1/4" BSP Female thread to waste (inner thread size $\text{\O}39.5\text{mm}$); Pipe size: $\text{\O}35\text{mm}$ outer diameter
Guarantee	1 years against manufacturing faults (excluding serviceable parts)

MINIMAL 1 1/4" BOTTLE TRAP & EXTENSION

WAP/488/C

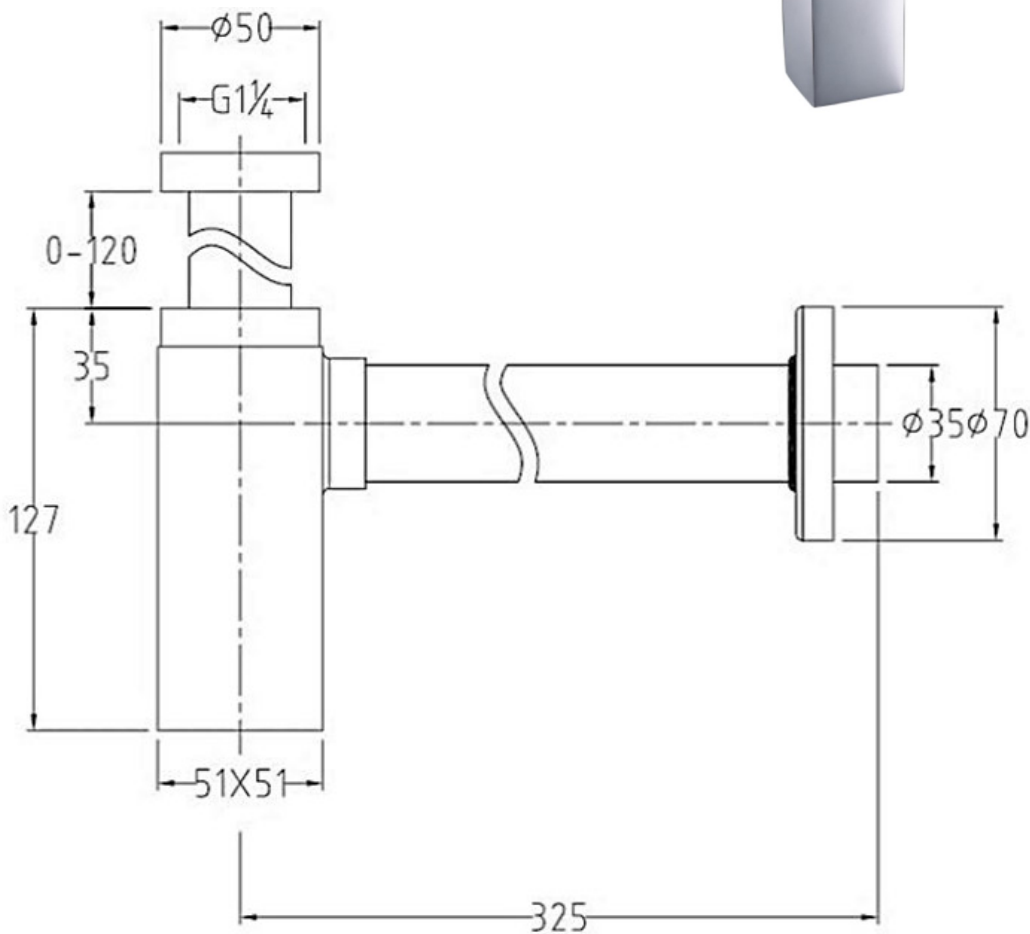

The information contained on this page was correct at the date of issue. Fitting dimensions are provided as a guide only. Some variation may occur due to manufacturing tolerances. We pursue a policy of continuing improvement in design and performance of our products and so reserve the right to change specifications without prior notice

FOR FURTHER ADVICE PLEASE CONTACT :-

SAGITTARIUS LTD UNIT 1 LOWER VICTORIA STREET—CHADDERTON—OLDHAM—OL9 9TU TEL:0616 6202029

EMAIL:TECHNICAL@SAGITTARIUSTAPS.CO.UK

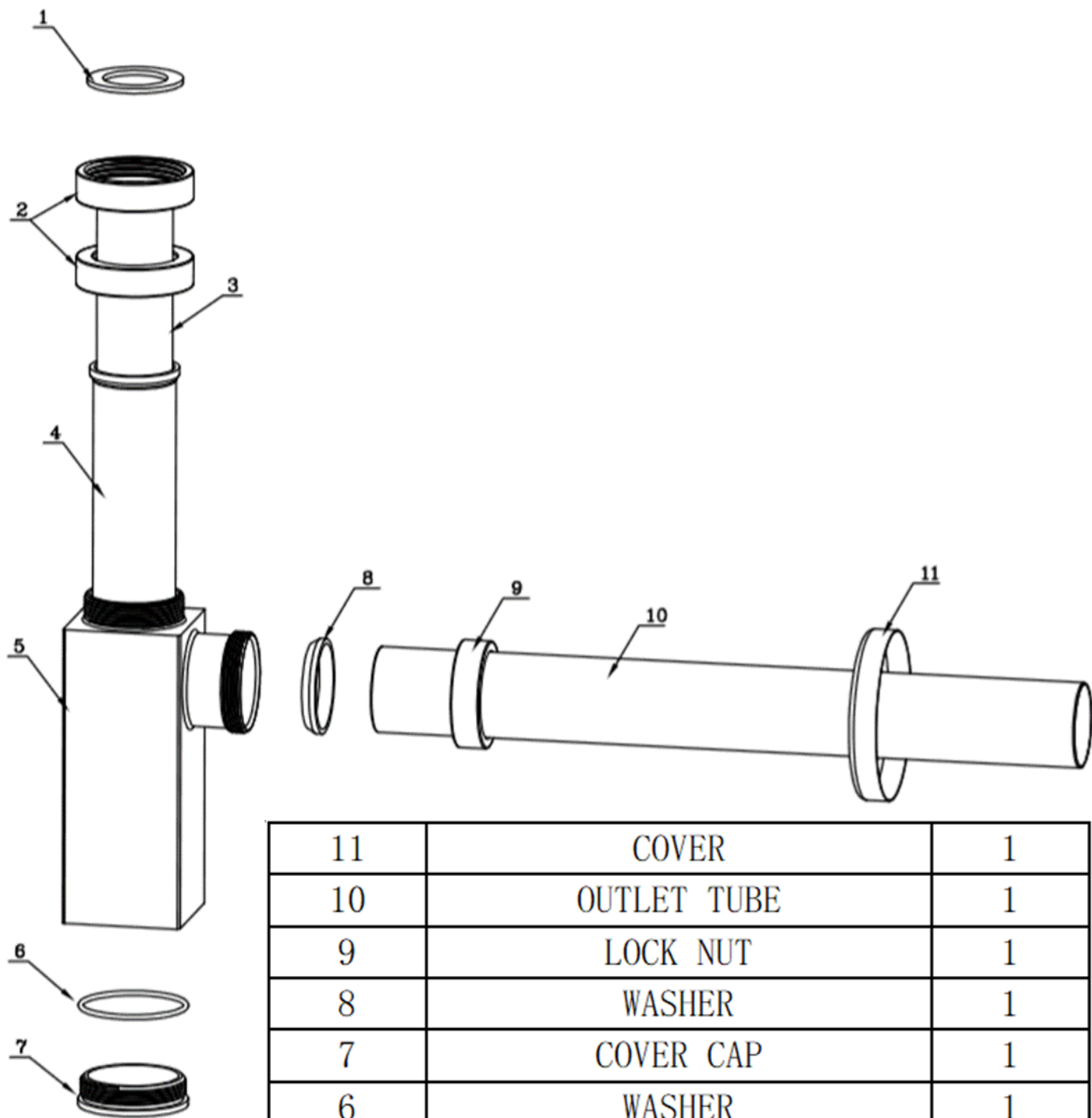

11	COVER	1
10	OUTLET TUBE	1
9	LOCK NUT	1
8	WASHER	1
7	COVER CAP	1
6	WASHER	1
5	CONNECTOR	1
4	PLASTIC TUBE	1
3	STAINLESS STEEL TUBE	1
2	LOCK NUT	2
1	WASHER	1
No.	DESCRIPTION	QTY

FOR FURTHER ADVICE PLEASE CONTACT :-

SAGITTARIUS LTD UNIT 1 LOWER VICTORIA STREET—CHADDERTON—OLDHAM—OL9 9TU TEL:0616 6202029

EMAIL:TECHNICAL@SAGITTARIUSTAPS.CO.UK