

SAGITTARIUS

TAPS & SHOWERING

Construction	Brass Body CuZn40Pb2, EN CW617N (equivalent to BS CZ122)
Finishes	Chrome plated to BS EN 248
Product Type	Contemporary
Water Pressure	Min. 0.5 bar, Max. 6.0 bar
Plumbing Systems	Suitable for all plumbing systems
Standards	Complies with BS5412, BS EN200
Certification	Manufactured to comply with WRAS
Cartridge	1/4 Turn 3/4" Ceramic Disc Valves
Fitting	Brass 3/4" BSP Tails
Aerator	Laminar
Packaging	49.5 x 41.5 x 33cm / carton (8 boxes / carton)
Guarantee	10 years against manufacturing faults (excluding serviceable parts).

ECLIPSE BATH FILLER

CHROME

EC/304/C

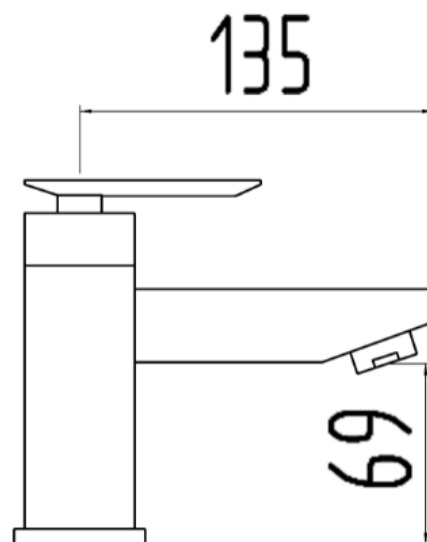
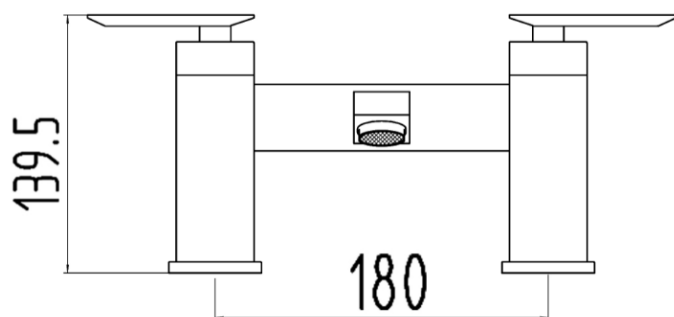

Flow Rates (Litres per minute)

System Pressure	0.1 Bar	0.2 Bar	0.3 Bar	0.5 Bar	1.0 Bar	1.5 Bar	2.0 Bar	3.0 Bar	4.0 Bar	5.0 Bar
EC/304/C	-	3.2	-	8.0	13.0	17.3	20.6	26.4	-	-

The information contained on this page was correct at the date of issue. Fitting dimensions are provided as a guide only. Some variation may occur due to manufacturing tolerances. We pursue a policy of continuing improvement in design and performance of our products and so reserve the right to change specifications without prior notice

FOR FURTHER ADVICE PLEASE CONTACT :-

SAGITTARIUS LTD UNIT 1 LOWER VICTORIA STREET—CHADDERTON—OLDHAM—OL9 9TU TEL:0616 6202029

EMAIL:TECHNICAL@SAGITTARIUSTAPS.CO.UK

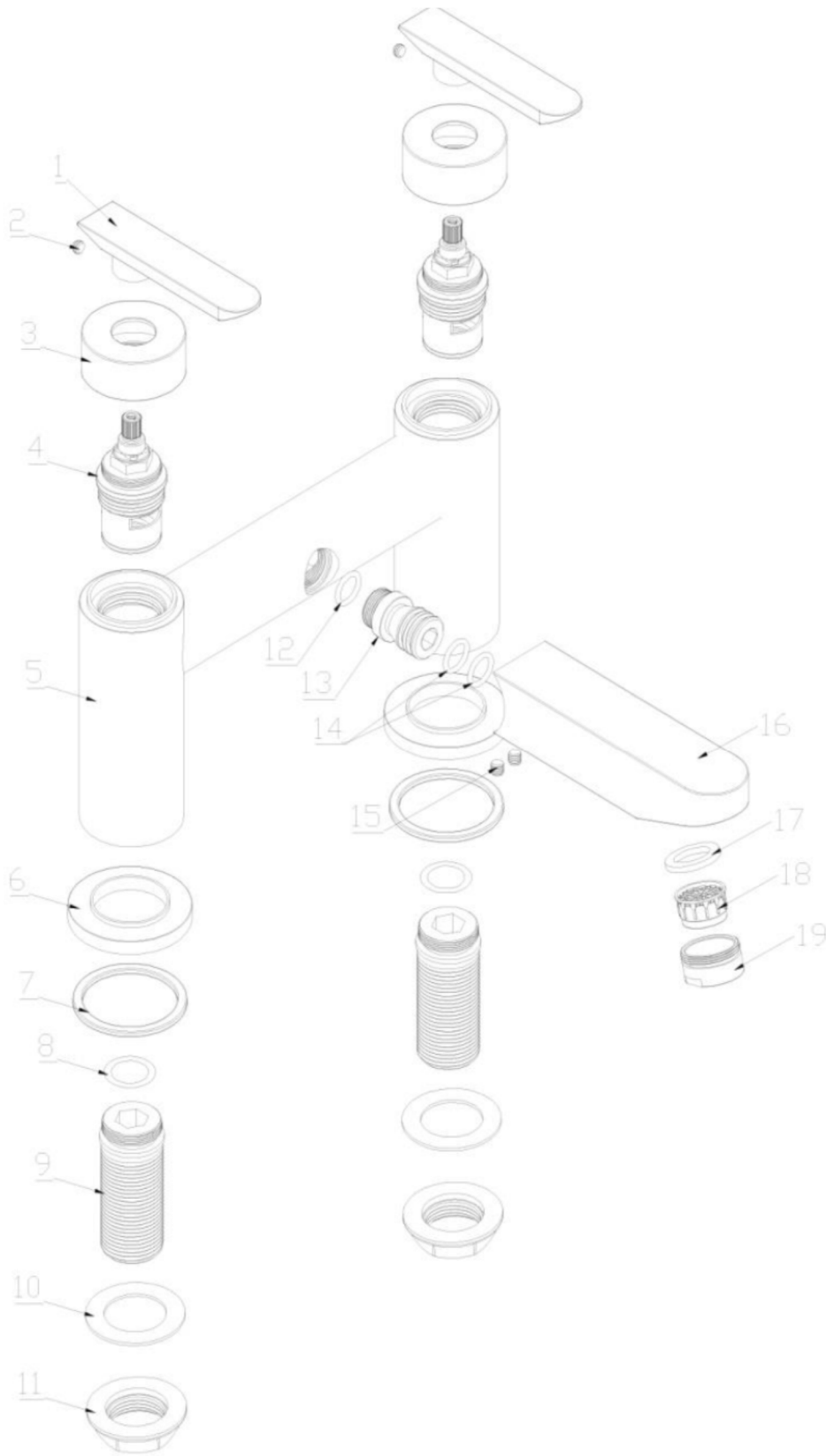

01	HANDLE LEVER	2
02	POINTED SCREW	2
03	COLLAR	2
04	1/4 TURN HOT CARTRIDGE	1
04	1/4 TURN COLD CARTRIDGE	1
05	TAP BODY	1
06	Ø50 BASE PLATE	2
07	WASHER	2
08	"O" RING	2
09	G3/4" INELT	2
10	WASHER	2
11	G3/4" BACKNUT	2
12	"O" RING	1
13	CONNECTOR	1
14	"O" RING	2
15	POINTED SCREW	2
16	SPOUT	1
17	WASHER	1
18	NEOPERL AERATOR	1
19	M24X1 NOZZLE	1

The information contained on this page was correct at the date of issue. Fitting dimensions are provided as a guide only. Some variation may occur due to manufacturing tolerances. We pursue a policy of continuing improvement in design and performance of our products and so reserve the right to change specifications without prior notice

FOR FURTHER ADVICE PLEASE CONTACT :-
 SAGITTARIUS LTD UNIT 1 LOWER VICTORIA STREET—CHADDERTON—OLDHAM—OL9 9TU TEL:0616 6202029
 EMAIL:TECHNICAL@SAGITTARIUSTAPS.CO.UK