

SAGITTARIUS

TAPS & SHOWERING

Construction	Brass body
Finish	Chrome
Product Type	Contemporary
Plumbing Systems	Min 0.2bar, Max 6.0bar
Cartridge	Ceramic disc valve
Guarantee	10 years on chrome finish, 3 years on serviceable parts
Additional Info	Valve is set factory set to max outlet temp 42c

AXIS EXPOSED THERMO
VALVE CHROME
AX/568/C

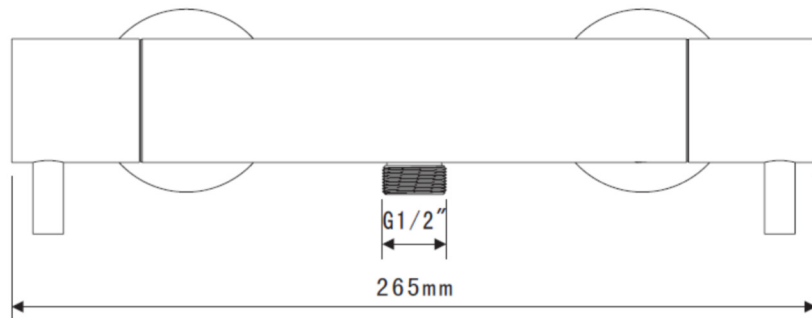
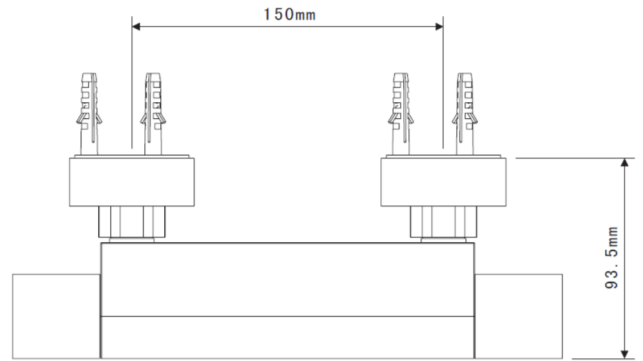

Flow Rates (Litres per minute)

System Pressure	0.1 Bar	0.2 Bar	0.3 Bar	0.5 Bar	1.0 Bar	1.5 Bar	2.0 Bar	3.0 Bar	4.0 Bar	5.0 Bar
AX/168/C	-	5.4	6.9	9.5	10.4	-	14.2	17.5	-	-

The information contained on this page was correct at the date of issue. Fitting dimensions are provided as a guide only. Some variation may occur due to manufacturing tolerances. We pursue a policy of continuing improvement in design and performance of our products and so reserve the right to change specifications without prior notice

FOR FURTHER ADVICE PLEASE CONTACT :-
SAGITTARIUS LTD UNIT 1 LOWER VICTORIA STREET—CHADDERTON—OLDHAM—OL9 9TU TEL:0616 6202029
EMAIL:TECHNICAL@SAGITTARIUSTAPS.CO.UK

INTRODUCTION

Your bar shower valve is a thermostatic mixer which incorporates a thermo-regulating cartridge to assure users of consistent showering temperatures. The valve has been designed & manufactured to comply with BS EN BS EN 1111:1999.

OPERATING CONDITIONS OF USE

Before installation the operating conditions of use must be checked. The table below contains details of the necessary conditions of operation. If your water supply cannot meet these conditions then the valve cannot be guaranteed to operate as a Type 2 TMV2 certified shower valve.

- Gravity fed Hot & Cold (equal pressures)
- Gravity fed Hot & mains Cold (equal pressures)
- Unvented systems
- Gas combination boiler
- Pumped system

Note: On gravity systems the minimum Vertical distance (Drop) from the underside of the cold water storage tank to the shower valve must be 2 metres.

CONDITIONS OF USE :

	HIGH PRESSURE
Maximum Static Pressure – BAR	10
Flow Pressure, Hot & Cold – BAR	0.5 to 5
Hot Supply Temperature – C	55 to 65
Cold Supply Temperature – C	Equal to or less than 25 C

NOTE:

Valves operating outside these conditions cannot be guaranteed by the Scheme to operate as Type 2 valves.

Recommended outlet temperatures

The BuildCert TMV scheme recommends the following set maximum mixed water outlet temperatures for use in all premises:

41 C for showers;

The mixed water temperatures must never exceed 46 C.

The maximum mixed water temperature can be 2 C above the recommended maximum set outlet temperatures.

NOTE :

46 C is the maximum mixed water temperature from the bath tap. The maximum temperature takes account of the allowable temperature tolerances inherent in thermostatic mixing valves and temperature losses in metal baths. It is not a safe bathing temperature for adults or children.

The British Burns Association recommends 37 to 37.5 C as a comfortable bathing temperature for children. In premises covered by the Care Standards Act 2000, the maximum mixed water outlet temperature is 43 C.

The thermostatic mixing valve will be installed in such a position that maintenance of the TMV and its valves and the commissioning and testing of the TMV can be undertaken.

The fitting of strainers is recommended as close as is practicable to the water supply inlets of the thermostatic mixing valve.

TROUBLE-SHOOTING

Problem	Solution
Shower will not run hot enough when first installed	Check for debris Check hot water temperature
Cold water running back through the valve into the hot water system.	Check and clean the check valve cartridges and filters located under the check valves.

If you require further assistance beyond the guide below contact the help line on *****

AFTERCARE INSTRUCTIONS

Whilst this item has a high quality durable finish, it should nevertheless be treated with care. Surfaces should be cleaned using only a soft damp cloth and clean water & dried using a soft cotton cloth. Bath / shower cleaning products, even non-scratch ones could damage the finished surface.

MAINTENANCE

We advise that the valves, check valves and filters be regularly serviced particularly in hard water areas. The check valves along with the filters are contained in the retaining nut. The water supplies must be isolated remotely from the valve before removal.

TMV2 approved valves shall be tested against the original set temperature results once a year. When testing is due the following performance checks shall be carried out.

1. Measure the mixed water temperature at the outlet.
2. Carry out the cold fail-safe shut off test by isolating the cold water supply to the TMV, wait for 5 seconds if water is still flowing check that the temperature is below 46 degrees C.
3. If there is no significant change to the set outlet temperature (+/- 2 C or less change from the original setting) and the fail safe shut off is functioning, then the valve is working correctly and no further service work is required.

If further maintenance should be required contact SAGITTARIUS LTD. for details. Please see contact details on the back page of this document.

COMMISSIONING & ANNUAL TEST

It is important that incoming water supplies conform to the requirements specified for pressure and temperature. Assure that supply water conditions satisfy any guidance information for the control of bacteria and that the designation of the supplied valve suits the application. Do not continue commissioning until supplies are correct and stable considering variation caused by other service users.

Use a calibrated thermometer for testing incoming and mixed water.

1. Record temperature of the incoming hot and cold supply.
2. Record temperature of mixed discharge at maximum draw off rate.
3. Record temperature of mixed discharge at minimum draw off rate.
4. Isolate the cold water supply and measure the mixed water temperature as the cold water failure device reacts. This should deviate by no more than + 2 °C of the initial maximum set point. Restore the cold supply and measure the stabilised mixed water temperature. This must not deviate by more than + / - 2 °C of the initial set recorded result. Record these findings.
5. Record the measuring equipment used for the measurements.

The above records must be retained and updated during the service life of the TMV .

If there is a residual flow during the commissioning or the annual verification (cold water supply isolation test), then this is acceptable providing the temperature of the water seeping from the valve is no more than 2°C above the designated maximum mixed water outlet temperature setting of the valve.

Temperature readings should be taken at the normal flow rate after allowing for the system to stabilise. The sensing part of the thermometer probe must be fully submerged in the water that is to be tested. Any TMV that has been adjusted or serviced must be re-commissioned and re-tested in accordance with the manufacturers' instructions.

The installation of thermostatic mixing valves must comply with the requirements of the Water Supply (Water Fittings) Regulations 1999.

VALVE INSTALLATION GUIDELINES AND COMPLIANCE

The valve must be installed so that it is readily accessible for commissioning and maintenance in accordance with the TMV2 scheme. The valve must be installed with isolation valves on both the hot and cold water systems as close as possible to the valve; so as to allow the valve to be commissioned and tested correctly. The valve is fitted with integral check valve cartridges which command the water supply, therefore the thermostatic valve is protected against cross-flow due to unbalanced line pressures as required by the Water Supply (Water Fittings) Regulations 1999.

Most problems associated with the operation of thermostatic shower valves are caused by debris in the new pipe work getting into the thermostat. These problems are easily avoided by thoroughly flushing the pipe work BEFORE the shower valve is fitted.

WATER SUPPLY – (WATER FITTINGS) REGULATIONS 1999

This valve complies with the requirements of the above regulations and installation should be carried out in strict compliance with them.

TEMPERATURE

This valve is factory set to a maximum outlet temperature of 42C / 107.6 F

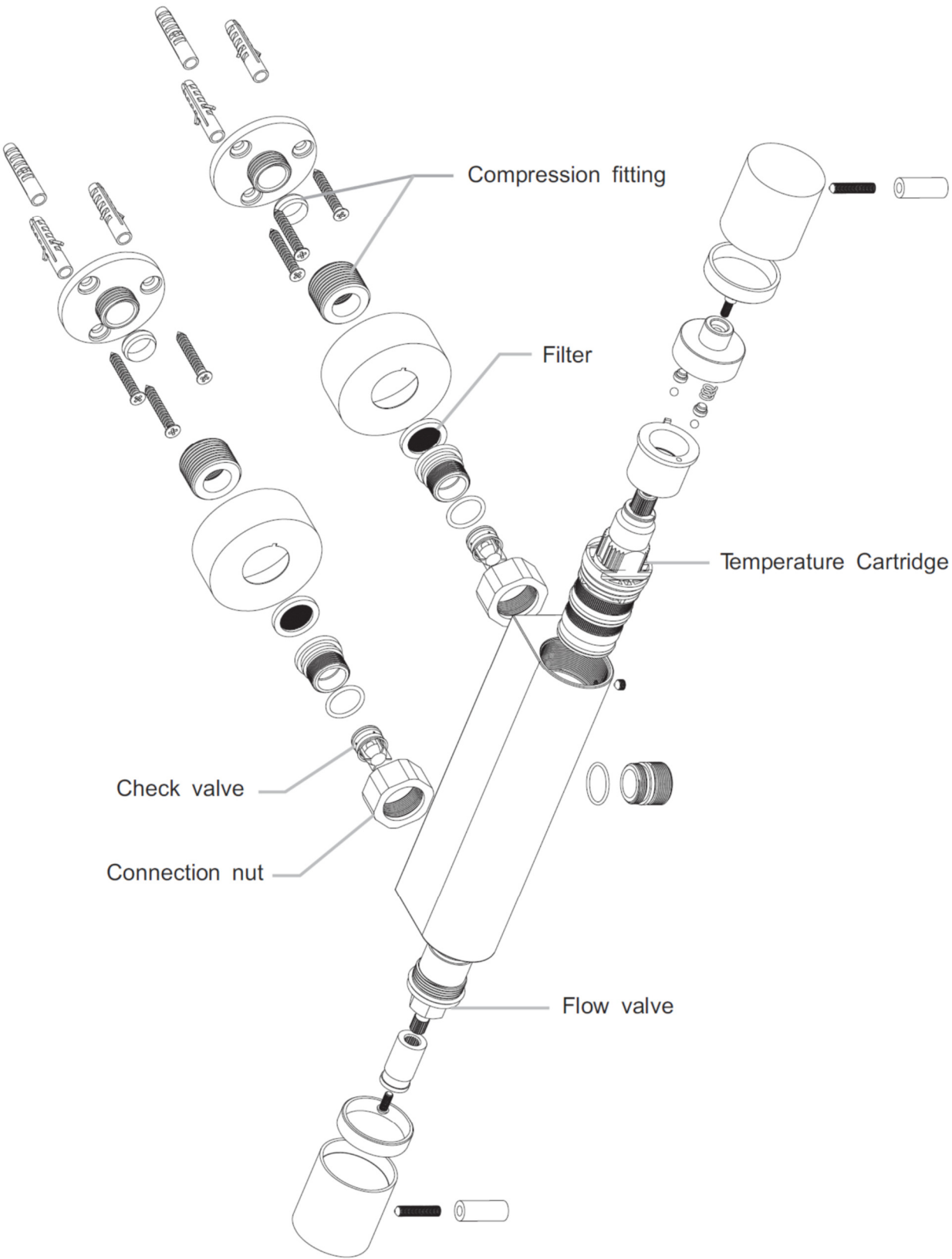

BOTTOM OUT LETBAR VALVE SHOWN

INSTALLATION

BOTTOM OUT LETBAR VALVE SHOWN

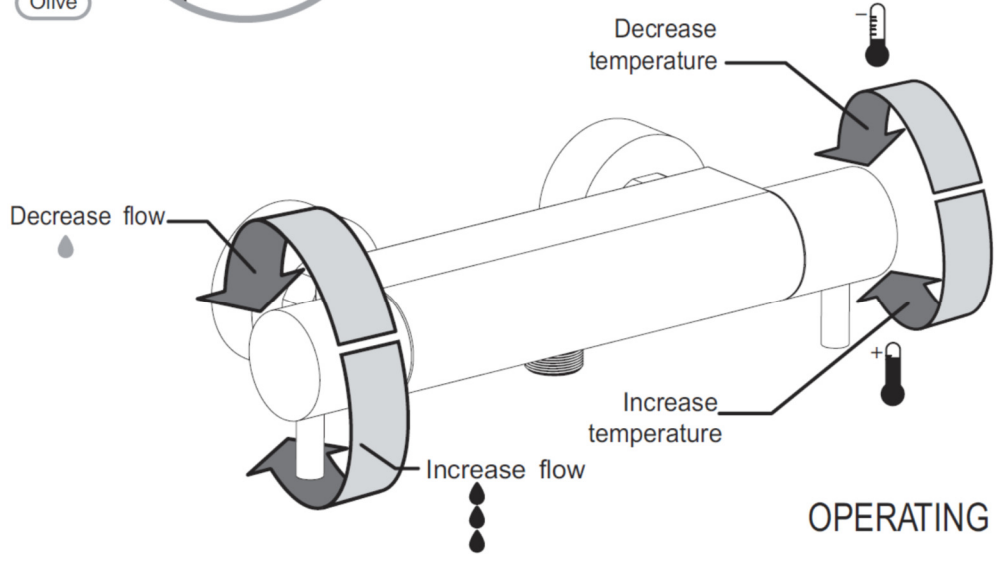
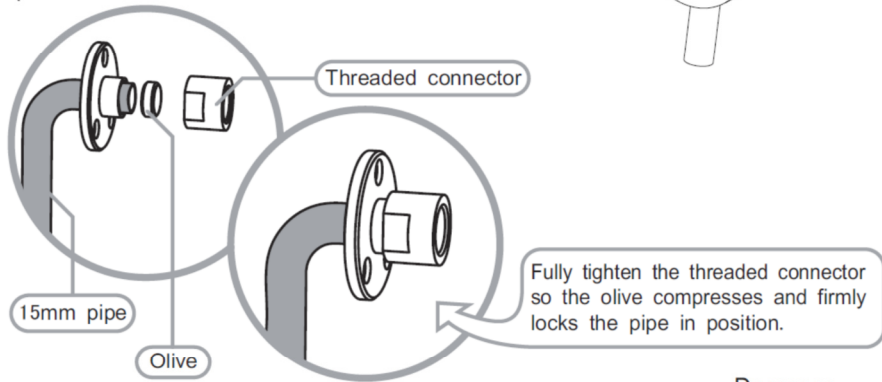
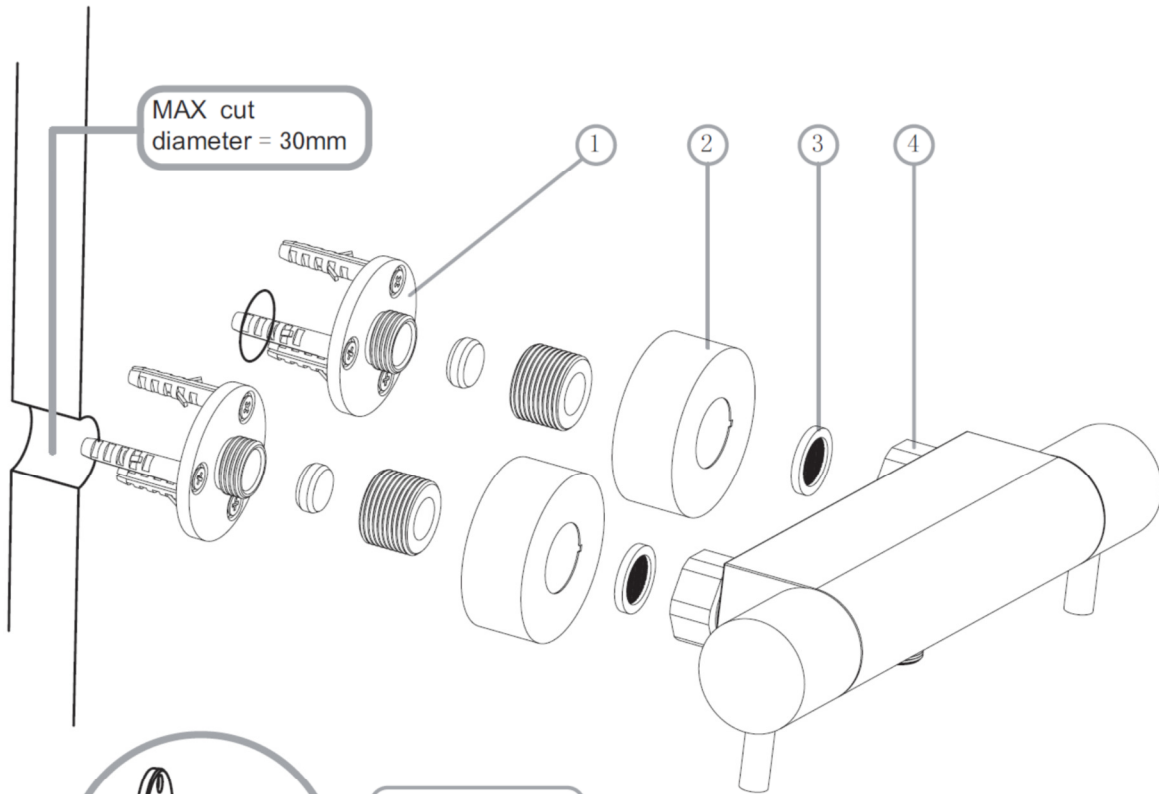

BOTTOM OUT LETBAR VALVE SHOWN

The information contained on this page was correct at the date of issue. Fitting dimensions are provided as a guide only. Some variation may occur due to manufacturing tolerances. We pursue a policy of continuing improvement in design and performance of our products and so reserve the right to change specifications without prior notice

FOR FURTHER ADVICE PLEASE CONTACT :-
SAGITTARIUS LTD UNIT 1 LOWER VICTORIA STREET—CHADDERTON—OLDHAM—OL9 9TU TEL:0616 6202029
EMAIL:TECHNICAL@SAGITTARIUSTAPS.CO.UK